



# 18



# TIEMME

[www.tiemme.com](http://www.tiemme.com)

# COPYRIGHT

18

**VALVOLE PER  
RADIATORI**

*RADIATOR VALVES*

Le valvole per riscaldamento Tiemme sono composte da corpo in ottone EN12165-CW617N nichelato o cromato con tenute in elastomero etilene-propilene (EPDM) e volantino di regolazione in ABS. Sono idonee per impieghi con temperatura massima di 110°C e pressione di esercizio massima di 10 bar.

*Tiemme radiator valves are assembled with nickel-plated or chrome-plated EN12165-CW617N brass with ethylene-propylene rubber (EPDM) seals and ABS head. Such valves are suitable for maximum temperature 110°C and maximum working pressure 10 bar.*

### SCelta ADATTATORI/ADAPTORs SELECTION

(VEDI/SEE Pag. 264 - 265 - 266 - 267 - 268 - 270)

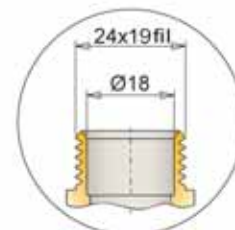
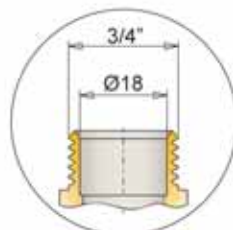
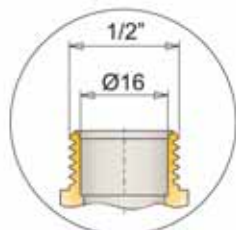
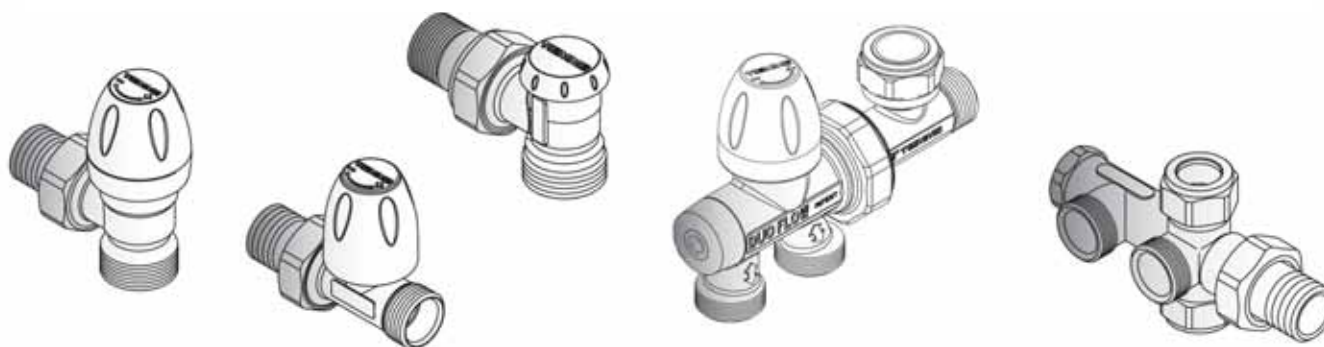

**Art. 1668 (1/2")**  
per tubi multistrato  
for multilayer pipe  
Ø14x2,0  
Ø16x2,0  
Ø18x2,0  
Ø20x2,0

**Art. 1666**  
per tubi multistrato  
for multilayer pipe  
Ø14x2,0  
Ø16x2,0  
Ø18x2,0  
Ø20x2,0

**Art. 1666K**  
per tubi multistrato  
for multilayer pipe  
Ø16x2,0  
Ø18x2,0  
Ø20x2,0



**Art. 1716**  
per tubi pe-x  
for pe-x pipe  
Ø16x1,8  
Ø16x2,0  
Ø20x1,9  
Ø20x2,0

**Art. 1716**  
per tubi pe-x  
for pe-x pipe  
Ø16x1,8  
Ø16x2,0  
Ø20x1,9  
Ø20x2,0  
Ø25x2,3

**Art. 1716K**  
per tubi pe-x  
for pe-x pipe  
Ø16x1,8  
Ø16x2,0  
Ø20x1,9  
Ø20x2,0



**Art. 1635**  
per tubi multistrato  
for multilayer pipe  
Ø14x2,0  
Ø16x2,0  
Ø16x2,25

**Art. 1636**  
per tubi multistrato  
for multilayer pipe  
Ø14x2,0 Ø16x2,0  
Ø16x2,25 Ø17x2,0  
Ø18x2,0 Ø20x2,0  
Ø20x2,25 Ø20x2,5

**Art. 1633K**  
per tubi multistrato  
for multilayer pipe  
Ø16x2,0  
Ø18x2,0  
Ø20x2,0



**Art. 1435**  
per tubi pe-x  
for pe-x pipe  
Ø12x1,1 - Ø12x2,0  
Ø14x2,0 - Ø15x2,5  
Ø16x1,5 - Ø16x2,0  
Ø16x2,2

**Art. 1436**  
per tubi pe-x  
for pe-x pipe  
Ø12x2,0 - Ø14x2,0  
Ø15x1,5 - Ø15x2,5  
Ø16x1,5 - Ø16x2,0  
Ø16x2,2 - Ø17x2,0  
Ø18x2,0 - Ø18x2,5  
Ø20x2,0 - Ø20x2,8

**Art. 1433K**  
per tubi pe-x  
for pe-x pipe  
Ø15x2,5 - Ø16x2,0  
Ø16x2,2 - Ø18x2,0  
Ø18x2,5 - Ø20x2,0



**Art. 1233 - 1235**  
per tubi in rame  
for copper pipe  
Ø10 - Ø12 - Ø14 - Ø16



**Art. 1240**  
per tubi in rame  
for copper pipe  
Ø10 - Ø12 - Ø14  
Ø15 - Ø16

**Art. 1241**  
per tubi in rame  
for copper pipe  
Ø10 - Ø12 - Ø14  
Ø15 - Ø16 - Ø18

**Art. 1243K**  
per tubi in rame  
for copper pipe  
Ø15 - Ø16 - Ø18

# VALVOLE TERMOSTATIZZABILI

## THERMOSTATIC VALVES



**ART. 3301**  
Valvola a squadra termostattizzabile con attacco per tubo rame /Pe-x/ multistrato  
*Angle valve with thermostatic option for copper/Pe-x/multilayer pipe*

CODICE Code	TIPO Size	ATTACCHI Connections	PREZZO Price €	CONF. Unit/Box
330 0017	G 3/8"	1/2" - 16	9,64	10/60
330 0002	G 1/2"	1/2" - 16	10,04	10/60
330 0066	G 3/8"	3/4" - 18	16,29	10/60
330 0046	G 1/2"	3/4" - 18	15,82	10/60
330 0097	G 1/2"	24x19 fil (Ø18)	12,37	10/60
Versione con O-ring / O-ring version				
330 0011	G 3/8"	1/2" - 16	10,16	10/60
330 0003	G 1/2"	1/2" - 16	10,57	10/60
330 0071	G 3/8"	3/4" - 18	16,82	10/60
330 0051	G 1/2"	3/4" - 18	16,37	10/60
330 0108	G 1/2"	24x19 fil (Ø18)	13,49	10/60

■ versione cromata / chrome-plated version



**ART. 3300**  
Valvola diritta termostattizzabile con attacco per tubo rame /Pe-x/ multistrato  
*Straight valve with thermostatic option for copper/Pe-x/multilayer pipe*

CODICE Code	TIPO Size	ATTACCHI Connections	PREZZO Price €	CONF. Unit/Box
330 0058	G 3/8"	1/2" - 16	11,50	10/60
330 0032	G 1/2"	1/2" - 16	11,91	10/60
330 0079	G 3/8"	3/4" - 18	13,33	10/60
330 0065	G 1/2"	3/4" - 18	13,56	10/60
330 0095	G 1/2"	24x19 fil (Ø18)	14,65	10/60
Versione con O-ring / O-ring version				
330 0048	G 3/8"	1/2" - 16	12,06	10/60
330 0036	G 1/2"	1/2" - 16	12,47	10/60
330 0082	G 3/8"	3/4" - 18	13,94	10/60
330 0083	G 1/2"	3/4" - 18	14,17	10/60
330 0109	G 1/2"	24x19 fil (Ø18)	15,44	10/60

■ versione cromata / chrome-plated version



**ART. 3306**  
Valvola a squadra termostattizzabile con attacco per tubo ferro  
*Angle valve with thermostatic option for iron pipe*

CODICE Code	TIPO Size	PREZZO Price €	CONF. Unit/Box
330 0023	G 3/8"	11,25	10/60
330 0005	G 1/2"	11,64	10/60
330 0022	G 3/4"	18,60	10/60
Versione con O-ring / O-ring version			
330 0029	G 3/8"	11,78	10/60
330 0026	G 1/2"	12,17	10/60
330 0053	G 3/4"	19,14	10/60



**ART. 3305**  
Valvola diritta termostattizzabile con attacco per tubo ferro  
*Straight valve with thermostatic option for iron pipe*

CODICE Code	TIPO Size	PREZZO Price €	CONF. Unit/Box
330 0050	G 3/8"	12,47	10/60
330 0013	G 1/2"	13,32	10/60
330 0015	G 3/4"	21,18	10/60
Versione con O-ring / O-ring version			
330 0040	G 3/8"	13,04	10/60
330 0035	G 1/2"	13,87	10/60
330 0049	G 3/4"	21,73	10/60



**ART. 3303**  
Valvola a squadra termostattizzabile con attacco per tubo rame /Pe-x/ multistrato. Versione con cappuccio di protezione  
*Angle valve with thermostatic option for copper/Pe-x/multilayer pipe with protection cap*

CODICE Code	TIPO Size	ATTACCHI Connections	PREZZO Price €	CONF. Unit/Box
330 0019	G 3/8"	1/2" - 16	9,09	10/60
330 0006	G 1/2"	1/2" - 16	9,50	10/60
330 0067	G 3/8"	3/4" - 18	15,47	10/60
330 0038	G 1/2"	3/4" - 18	15,04	10/60
Versione con O-ring / O-ring version				
330 0064	G 3/8"	1/2" - 16	9,64	10/60
330 0028	G 1/2"	1/2" - 16	10,04	10/60
330 0088	G 3/8"	3/4" - 18	15,98	10/60
330 0076	G 1/2"	3/4" - 18	15,55	10/60



**ART. 3302**  
Valvola diritta termostattizzabile con attacco per tubo rame /Pe-x/ multistrato. Versione con cappuccio di protezione  
*Straight valve with thermostatic option for copper/Pe-x/multilayer pipe with protection cap*

CODICE Code	TIPO Size	ATTACCHI Connections	PREZZO Price €	CONF. Unit/Box
330 0070	G 3/8"	1/2" - 16	10,93	10/60
330 0034	G 1/2"	1/2" - 16	11,36	10/60
330 0080	G 3/8"	3/4" - 18	12,73	10/60
330 0073	G 1/2"	3/4" - 18	12,95	10/60
Versione con O-ring / O-ring version				
330 0078	G 3/8"	1/2" - 16	11,50	10/60
330 0068	G 1/2"	1/2" - 16	11,91	10/60
330 0087	G 3/8"	3/4" - 18	13,33	10/60
330 0081	G 1/2"	3/4" - 18	13,56	10/60

## VALVOLE TERMOSTATIZZABILI

### THERMOSTATIC VALVES



#### ART. 3308

Valvola a squadra termostattizzabile con attacco per tubo ferro. Versione con cappuccio di protezione  
*Angle valve with thermostatic option for iron pipe with protection cap*

CODICE Code	TIPO Size	PREZZO Price €	CONF. Unit/Box
330 0031	G 3/8"	10,71	10/60
330 0001	G 1/2"	11,10	10/60
330 0027	G 3/4"	18,07	10/60
Versione con O-ring / O-ring version			
330 0057	G 3/8"	11,25	10/60
330 0055	G 1/2"	11,64	10/60
330 0075	G 3/4"	18,62	10/60



#### ART. 3307

Valvola diritta termostattizzabile con attacco per tubo ferro. Versione con cappuccio di protezione  
*Straight valve with thermostatic option for iron pipe with protection cap*

CODICE Code	TIPO Size	PREZZO Price €	CONF. Unit/Box
330 0047	G 3/8"	11,91	10/60
330 0012	G 1/2"	12,75	10/60
330 0007	G 3/4"	20,61	10/60
Versione con O-ring / O-ring version			
330 0069	G 3/8"	12,47	10/60
330 0074	G 1/2"	13,32	10/60
330 0063	G 3/4"	21,19	10/60



#### ART. 3312

Valvola reversa termostattizzabile con attacco per tubo rame/Pe-x/multistrato. Versione con cappuccio di protezione  
*Reverse thermostatic valve with protection cap, for copper/pe-x/multilayer pipe*

**NEW**

CODICE Code	TIPO Size	ATTACCHI Connections	PREZZO Price €	CONF. Unit/Box
331 0007	G 1/2"	3/4" - 18	19,57	10/60
Versione con O-ring / O-ring version				
331 0008	G 1/2"	3/4" - 18	20,14	10/60



#### ART. 3313

Valvola reversa termostattizzabile con attacco per tubo ferro. Versione con cappuccio di protezione  
*Reverse thermostatic valve with protection cap, for iron pipe*

**NEW**

CODICE Code	TIPO Size	PREZZO Price €	CONF. Unit/Box
331 0009	G 1/2"	19,57	10/60
Versione con O-ring / O-ring version			
331 0010	G 1/2"	20,14	10/60

## DETTENTORI PER RADIATORI

### LOCKSHIELDS FOR RADIATORS



#### ART. 3331

Detentore a squadra con attacco per tubo rame/Pe-x/multistrato  
*Angle lockshield for copper/Pe-x/multilayer pipe*

CODICE Code	TIPO Size	ATTACCHI Connections	PREZZO Price €	CONF. Unit/Box
333 0007	G 3/8"	1/2" - 16	7,48	10/60
333 0002	G 1/2"	1/2" - 16	7,55	10/60
333 0033	G 3/8"	3/4" - 18	13,84	10/60
333 0013	G 1/2"	3/4" - 18	13,45	10/60
333 0043	G 1/2"	24x19 fil (Ø18)	14,12	1/60
Versione con O-ring / O-ring version				
333 0008	G 3/8"	1/2" - 16	8,11	10/60
333 0003	G 1/2"	1/2" - 16	8,19	10/60
333 0029	G 3/8"	3/4" - 18	14,30	10/60
333 0025	G 1/2"	3/4" - 18	13,91	10/60
333 0044	G 1/2"	24x19 fil (Ø18)	14,61	1/60

■ versione cromata / chrome-plated version



#### ART. 3330

Detentore diritto con attacco per tubo rame/Pe-x/multistrato  
*Straight lockshield for copper/Pe-x/multilayer pipe*

CODICE Code	TIPO Size	ATTACCHI Connections	PREZZO Price €	CONF. Unit/Box
333 0032	G 3/8"	1/2" - 16	8,49	10/60
333 0021	G 1/2"	1/2" - 16	8,58	10/60
333 0038	G 3/8"	3/4" - 18	9,90	10/60
333 0019	G 1/2"	3/4" - 18	9,90	10/60
333 0039	G 1/2"	24x19 fil (Ø18)	10,40	1/60
Versione con O-ring / O-ring version				
333 0030	G 3/8"	1/2" - 16	9,16	10/60
333 0023	G 1/2"	1/2" - 16	9,26	10/60
333 0041	G 3/8"	3/4" - 18	10,60	10/60
333 0028	G 1/2"	3/4" - 18	10,60	10/60
333 0040	G 1/2"	24x19 fil (Ø18)	11,14	1/60

■ versione cromata / chrome-plated version

## DETENTORI PER RADIATORI

### LOCKSHIELDS FOR RADIATORS



#### ART. 3336

Detentore a squadra con attacco tubo ferro  
Angle lockshield for iron pipe

CODICE Code	TIPO Size	PREZZO Price €	CONF. Unit/Box
333 0014	G 3/8"	8,56	10/60
333 0006	G 1/2"	8,19	10/60
333 0011	G 3/4"	19,34	10/60
333 0050	G 1/2"	8,60	1/60
333 0052	G 3/4"	20,31	1/60
Versione con O-ring / O-ring version			
333 0015	G 3/8"	9,06	10/60
333 0010	G 1/2"	8,84	10/60
333 0017	G 3/4"	19,96	10/60
333 0051	G 1/2"	9,28	1/60
333 0053	G 3/4"	20,96	1/60

■ versione cromata / chrome-plated version



#### ART. 3335

Detentore diritto con attacco per tubo ferro  
Straight lockshield for iron pipe

CODICE Code	TIPO Size	PREZZO Price €	CONF. Unit/Box
333 0027	G 3/8"	9,39	10/60
333 0009	G 1/2"	9,16	10/60
333 0004	G 3/4"	21,32	10/60
333 0046	G 1/2"	9,63	1/60
333 0048	G 3/4"	22,37	1/60
Versione con O-ring / O-ring version			
333 0024	G 3/8"	10,11	10/60
333 0026	G 1/2"	9,85	10/60
333 0031	G 3/4"	21,99	10/60
333 0047	G 1/2"	10,34	1/60
333 0049	G 3/4"	23,08	1/60

■ versione cromata / chrome-plated version

## VALVOLE PER TERMOARREDO

### CHROME-PLATED RADIATOR VALVES



#### ART. 3301C

Valvola a squadra termostattizzabile con attacco per tubo rame/Pe-x/multistrato - Versione cromata lucida  
Angle valve with thermostatic option for copper/Pe-x/multilayer pipe - Bright chrome-plated

CODICE Code	TIPO Size	ATTACCHI Connections	PREZZO Price €	CONF. Unit/Box
330 0042	G 3/8"	1/2" - 16	17,52	10/60
330 0009	G 1/2"	1/2" - 16	18,33	10/60



#### ART. 3300C

Valvola diretta termostattizzabile con attacco per tubo rame/Pe-x/multistrato - Versione cromata lucida  
Straight valve with thermostatic option for copper/Pe-x/multilayer pipe - Bright chrome-plated

CODICE Code	TIPO Size	ATTACCHI Connections	PREZZO Price €	CONF. Unit/Box
330 0059	G 3/8"	1/2" - 16	21,45	10/60
330 0041	G 1/2"	1/2" - 16	22,43	10/60



#### ART. 3306C

Valvola a squadra termostattizzabile con attacco per tubo ferro - Versione cromata lucida  
Angle valve with thermostatic option, for iron pipe. - Bright chrome-plated

CODICE Code	TIPO Size	PREZZO Price €	CONF. Unit/Box
330 0061	G 3/8"	19,68	10/60
330 0016	G 1/2"	21,96	10/60



#### ART. 3305C

Valvola diretta termostattizzabile con attacco per tubo ferro - Versione cromata lucida  
Straight valve with thermostatic option for iron pipe - Bright chrome-plated

CODICE Code	TIPO Size	PREZZO Price €	CONF. Unit/Box
330 0060	G 3/8"	21,73	10/60
330 0025	G 1/2"	24,53	10/60



#### ART. 1240C

Per tubo rame/for copper pipe  
Dado cromato + ogiva incorporata per attacco 1/2" x 16  
Chrome-plated nut with brass and rubber rings for rif. 1/2" x 16

CODICE Code	TIPO Size	PREZZO Price €	CONF. Unit/Box
144 0084	10 x 1/2"	3,79	10/400
144 0050	12 x 1/2"	3,71	10/400
144 0067	14 x 1/2"	3,67	10/400
144 0066	15 x 1/2"	3,71	10/400
144 0081	16 x 1/2"	4,05	10/400



#### ART. 1635C

Per tubo multistrato for multilayer pipe  
Adattatore cromato per attacchi 1/2" x 16  
Chrome-plated adapter for 1/2" x 16 connections

CODICE Code	TIPO Size	PREZZO Price €	CONF. Unit/Box
144 0065	14 sp 2,0 x 1/2"	4,27	10/350
144 0035	16 sp 2,0 x 1/2"	3,92	10/300
144 0079	16 sp 2,25 x 1/2"	4,31	10/300

## DETENTORI PER TERMOARREDO

### CHROME-PLATED PANEL LOCKSHIELDS



#### ART. 3331C

Detentore a squadra con attacco per tubo rame/Pe-x/multistrato - Versione cromata lucida  
Angle lockshield for copper/Pe-x/multilayer pipe - Bright chrome-plated

CODICE Code	TIPO Size	ATTACCHI Connections	PREZZO Price €	CONF. Unit/Box
333 0016	G 3/8"	1/2" - 16	16,36	10/60
333 0005	G 1/2"	1/2" - 16	16,51	10/60



#### ART. 3330C

Detentore dritto con attacco per tubo rame/Pe-x/multistrato - Versione cromata lucida  
Straight lockshield for copper/Pe-x/multilayer pipe - Bright chrome-plated

CODICE Code	TIPO Size	ATTACCHI Connections	PREZZO Price €	CONF. Unit/Box
333 0036	G 3/8"	1/2" - 16	17,14	10/60
333 0018	G 1/2"	1/2" - 16	17,29	10/60



#### ART. 3336C

Detentore a squadra con attacco per tubo ferro - Versione cromata lucida  
Angle lockshield for iron pipe - Bright chrome-plated

CODICE Code	TIPO Size	PREZZO Price €	CONF. Unit/Box
333 0035	G 3/8"	18,42	10/60
333 0001	G 1/2"	18,42	10/60



#### ART. 3335C

Detentore dritto con attacco tubo ferro - Versione cromata lucida  
Straight lockshield for iron pipe - Bright chrome-plated

CODICE Code	TIPO Size	PREZZO Price €	CONF. Unit/Box
333 0034	G 3/8"	19,29	10/60
333 0012	G 1/2"	19,29	10/60

## COMANDI TERMOSTATICI

### THERMOSTATIC CONTROLS

Testa  
termostatica  
Serie  
Thermostatic head  
Series



Heating  
Controller



#### ART. 9557

Testa termostatica con elemento sensibile a liquido incorporato  
Thermostatic head with liquid sensitive element

CODICE Code	ATTACCO Connection	PREZZO Price €	CONF. Unit/Box
955 0001	M30 x 1,5	13,95	1/30



#### ART. 9557C

Testa termostatica con elemento sensibile a liquido incorporato cromata  
Thermostatic head with liquid sensitive element chrome-plated

CODICE Code	ATTACCO Connection	PREZZO Price €	CONF. Unit/Box
955 0004	M30 x 1,5	18,03	1/30



#### ART. 9557CA

Testa termostatica con elemento sensibile a liquido incorporato cromata/bianco  
Thermostatic head with liquid sensitive element chrome-plated/white

CODICE Code	ATTACCO Connection	PREZZO Price €	CONF. Unit/Box
955 0002	M30 x 1,5	17,63	1/30



#### ART. 9557CB

Testa termostatica con elemento sensibile a liquido incorporato bianco/cromata  
Thermostatic head with liquid sensitive element white/chrome-plated

CODICE Code	ATTACCO Connection	PREZZO Price €	CONF. Unit/Box
955 0005	M30 x 1,5	17,63	1/30



#### ART. 9558

Testa termostatica con elemento sensibile a liquido a distanza (lunghezza capillare 2 m)  
Thermostatic head with distance liquid sensitive element (length 2 m)

CODICE Code	ATTACCO Connection	PREZZO Price €	CONF. Unit/Box
955 0003	-	52,84	1/1



#### ART. 9560

Anello antimanomissione per testa termostatica  
Tamper-proof cap for thermostatic head

CODICE Code	TIPO Size	PREZZO Price €	CONF. Unit/Box
955 0006	unica - single	6,21	1/1

## KIT VALVOLE TERMOSTATIZZABILI

### KIT VALVES WITH THERMOSTATIC OPTION



#### ART. 3303KIT

Kit 3 pezzi composto da: valvola a squadra, testa termostatica e detentore con attacco per tubo rame / Pe-x / multistrato  
 3-pieces kit composed of: angle valve, thermostatic head and lockshields for copper/Pe-x/multilayer pipe

CODICE Code	TIPO Size	ATTACCHI Connections	PREZZO Price €	CONF. Unit/Box
330 0010	G 3/8"	1/2" - 16	27,22	1/10
330 0004	G 1/2"	1/2" - 16	27,65	1/10
330 0077	G 3/8"	3/4" - 18	38,43	1/10
330 0030	G 1/2"	3/4" - 18	37,71	1/10



#### ART. 3302KIT

Kit 3 pezzi composto da: valvola diritta, testa termostatica e detentore con attacco per tubo rame / Pe-x / multistrato  
 3-pieces kit composed of: straight valve, thermostatic head and lockshields for copper/Pe-x/multilayer pipe

CODICE Code	TIPO Size	ATTACCHI Connections	PREZZO Price €	CONF. Unit/Box
330 0056	G 3/8"	1/2" - 16	30,33	1/10
330 0039	G 1/2"	1/2" - 16	30,79	1/10
330 0090	G 3/8"	3/4" - 18	33,14	1/10
330 0054	G 1/2"	3/4" - 18	33,34	1/10

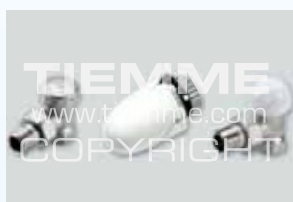

#### ART. 3308KIT

Kit 3 pezzi composto da: valvola a squadra, testa termostatica e detentore con attacco per tubo ferro  
 3-pieces kit composed of: angle valve, thermostatic head and lockshields for iron pipe

CODICE Code	TIPO Size	PREZZO Price €	CONF. Unit/Box
330 0014	G 3/8"	29,59	1/10
330 0018	G 1/2"	29,62	1/10
330 0037	G 3/4"	45,56	1/10



#### ART. 3307KIT

Kit a 3 pezzi composto da: valvola diritta, testina termostatica e detentore diritto con attacco per tubo ferro  
 3-pieces kit composed of: straight valve, thermostatic head and lockshield for iron pipe

CODICE Code	TIPO Size	PREZZO Price €	CONF. Unit/Box
330 0052	G 3/8"	32,00	1/10
330 0033	G 1/2"	32,53	1/10
330 0062	G 3/4"	50,14	1/10

## VALVOLE MANUALI SERIE "MAXIMA" PER RADIATORI

### "MAXIMA" MANUAL VALVES FOR RADIATOR



#### ART. 3321

Valvola a squadra manuale con attacco per tubo rame / Pe-x / multistrato.  
 Versione cromata  
 Manual valve for copper/Pe-x multilayer pipe.  
 Chrome-plated version

CODICE Code	TIPO Size	ATTACCHI Connections	PREZZO Price €	CONF. Unit/Box
332 0002	G 1/2"	24x19 fil (Ø18)	8,69	1/60
Versione con O-ring / O-ring version				
332 0007	G 1/2"	24x19 fil (Ø18)	9,48	1/60



#### ART. 3320

Valvola manuale diritta con attacco per tubo rame / Pe-x / multistrato.  
 Versione cromata  
 Straight manual valve for copper/Pe-x/multilayer pipe.  
 Chrome-plated version

CODICE Code	TIPO Size	ATTACCHI Connections	PREZZO Price €	CONF. Unit/Box
332 0005	G 1/2"	24x19 fil (Ø18)	9,10	1/60
Versione con O-ring / O-ring version				
332 0013	G 1/2"	24x19 fil (Ø18)	9,87	1/60



#### ART. 3326

Valvola a squadra manuale con attacco per tubo ferro.  
 Versione cromata  
 Manual valve for iron pipe.  
 Chrome-plated version

CODICE Code	TIPO Size	PREZZO Price €	CONF. Unit/Box
332 0001	G 1/2"	8,43	1/60
332 0008	G 3/4"	13,04	1/60
Versione con O-ring / O-ring version			
332 0010	G 1/2"	9,13	1/60
332 0012	G 3/4"	13,62	1/60



#### ART. 3325

Valvola manuale diritta con attacco per tubo ferro.  
 Versione cromata  
 Straight manual valve for iron pipe.  
 Chrome-plated version

CODICE Code	TIPO Size	PREZZO Price €	CONF. Unit/Box
332 0003	G 1/2"	8,82	1/60
332 0009	G 3/4"	13,53	1/60
Versione con O-ring / O-ring version			
332 0011	G 1/2"	9,53	1/60
332 0014	G 3/4"	14,11	1/60

## VALVOLE MANUALI SERIE "EXCEL" PER RADIATORI RADIATOR MANUAL VALVES "EXCEL" SERIES



### ART. 3221EXCEL

Valvola manuale a squadra con attacco per tubo rame/Pe-x/multistrato  
Angle manual valve for copper/Pe-x/multilayer pipe

CODICE Code	TIPO Size	ATTACCHI Connections	PREZZO Price €	CONF. Unit/Box
322 0004	G 3/8"	1/2" - 16	5,59	10/60
322 0002	G 1/2"	1/2" - 16	5,30	10/60
322 0006	G 1/2"	24x19 fil (Ø18)	7,08	1/60
Versione con O-ring / O-ring version				
322 0005	G 3/8"	1/2" - 16	6,26	10/60
322 0008	G 1/2"	1/2" - 16	6,19	10/60
322 0019	G 1/2"	24x19 fil (Ø18)	7,82	1/60

■ versione cromata / chrome-plated version



### ART. 3220EXCEL

Valvola manuale diritta con attacco per tubo rame/Pe-x/multistrato  
Straight manual valve for copper/Pe-x/multilayer pipe

CODICE Code	TIPO Size	ATTACCHI Connections	PREZZO Price €	CONF. Unit/Box
322 0015	G 3/8"	1/2" - 16	6,17	10/60
322 0007	G 1/2"	1/2" - 16	6,44	10/60
322 0014	G 1/2"	24x19 fil (Ø18)	7,45	1/60
Versione con O-ring / O-ring version				
322 0018	G 3/8"	1/2" - 16	6,84	10/60
322 0011	G 1/2"	1/2" - 16	7,10	10/60
322 0023	G 1/2"	24x19 fil (Ø18)	8,20	1/60

■ versione cromata / chrome-plated version



### ART. 3226EXCEL

Valvola manuale a squadra con attacco per tubo ferro  
Angle manual valve for iron pipe

CODICE Code	TIPO Size	PREZZO Price €	CONF. Unit/Box
322 0009	G 3/8"	6,49	10/60
322 0001	G 1/2"	5,70	10/60
322 0017	G 3/4"	11,97	10/60
Versione con O-ring / O-ring version			
322 0010	G 1/2"	6,84	10/60
322 0026	G 3/4"	12,54	10/60



### ART. 3225EXCEL

Valvola manuale diritta con attacco per tubo ferro  
Straight manual valve for iron pipe

CODICE Code	TIPO Size	PREZZO Price €	CONF. Unit/Box
322 0012	G 3/8"	6,67	10/60
322 0003	G 1/2"	6,67	10/60
322 0016	G 3/4"	14,01	10/60
Versione con O-ring / O-ring version			
322 0020	G 1/2"	7,33	10/60
322 0025	G 3/4"	14,59	10/60



# DETENTORI SERIE "EXCEL" PER RADIATORI

## LOCKSHIELDS RADIATORS "EXCEL" SERIES



### ART. 3231EXCEL

Detentore a squadra con attacco per tubo rame/Pe-x/multistrato  
Angle lockshield for copper/Pe-x/  
multilayer pipe

CODICE Code	TIPO Size	ATTACCHI Connections	PREZZO Price €	CONE. Unit/Box
323 0004	G 3/8"	1/2" - 16	5,01	10/60
323 0002	G 1/2"	1/2" - 16	4,98	10/60
323 0017	G 1/2"	24x19 fil (Ø18)	6,77	1/60
Versione con O-ring / O-ring version				
323 0005	G 3/8"	1/2" - 16	5,74	10/60
323 0006	G 1/2"	1/2" - 16	6,00	10/60
323 0026	G 1/2"	24x19 fil (Ø18)	7,60	1/60

■ versione cromata / chrome-plated version



### ART. 3230EXCEL

Detentore dritto con attacco per tubo rame/Pe-x/multistrato  
Straight lockshield for copper/Pe-x/  
multilayer pipe

CODICE Code	TIPO Size	ATTACCHI Connections	PREZZO Price €	CONE. Unit/Box
323 0012	G 3/8"	1/2" - 16	5,51	10/60
323 0007	G 1/2"	1/2" - 16	5,93	10/60
323 0011	G 1/2"	24x19 fil (Ø18)	7,14	1/60
Versione con O-ring / O-ring version				
323 0015	G 3/8"	1/2" - 16	6,33	10/60
323 0019	G 1/2"	1/2" - 16	6,72	10/60
323 0024	G 1/2"	24x19 fil (Ø18)	7,89	1/60

■ versione cromata / chrome-plated version



### ART. 3236EXCEL

Detentore a squadra con attacco per tubo ferro  
Angle lockshield for iron pipe

CODICE Code	TIPO Size	PREZZO Price €	CONE. Unit/Box
323 0009	G 3/8"	5,47	10/60
323 0001	G 1/2"	5,02	10/60
323 0013*	G 3/4"	11,32	10/60
Versione con O-ring / O-ring version			
323 0008	G 1/2"	6,18	10/60
323 0023*	G 3/4"	11,89	10/60

\* Con cappuccio nichelato / with nickel-plated cap



### ART. 3235EXCEL

Detentore dritto con attacco per tubo ferro  
Straight lockshield for iron pipe

CODICE Code	TIPO Size	PREZZO Price €	CONE. Unit/Box
323 0010	G 3/8"	5,64	10/60
323 0003	G 1/2"	5,64	10/60
323 0014*	G 3/4"	12,75	10/60
Versione con O-ring / O-ring version			
323 0016	G 1/2"	6,38	10/60
323 0018*	G 3/4"	13,32	10/60

\* Con cappuccio nichelato / with nickel-plated cap



**ART. 3382K**  
Valvola manuale monotubo "DUOFLOW MAXIMA" ad ingresso acqua reversibile  
Single pipe manual valve "DUOFLOW MAXIMA" with reversible flow inlet

CODICE Code	TIPO Size	ATTACCHI Connections	PREZZO Price €	CONF. Unit/Box
338 0001	G 1/2"	24x19 fil (Ø18)	35,54	1/20

### ART. 3382K

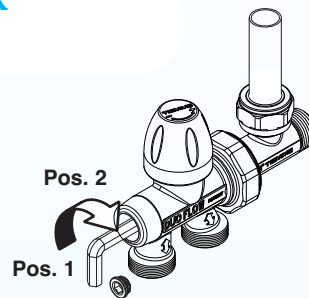

Pos. 2

Pos. 1

Ruotare di 180° in senso orario  
Turn 180° clockwise



**ART. 3385K**  
Valvola monotubo completa di sonda interna metallica (lunghezza 45 cm)  
Single pipe valve with internal metallic probe (45 cm length)

CODICE Code	TIPO Size	ATTACCHI Connections	PREZZO Price €	CONF. Unit/Box
338 0003	G 1/2"	24x19 fil (Ø18)	31,70	1/20

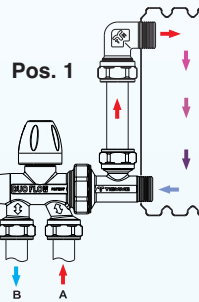

Pos. 1

Collegamento standard  
Standard connection

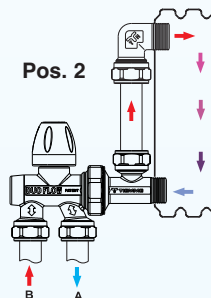

Pos. 2

Collegamento con ingresso invertito  
Reversed inlet connection



**ART. 3383K**  
Valvola mono/bitubo "DUAL" ad ingresso acqua reversibile completa di sonda metallica Ø10 mm di lunghezza 45 cm  
Single/double pipe valve "DUAL" with reversible flow inlet provided with Ø10 mm metallic probe 45 cm length

CODICE Code	TIPO Size	ATTACCHI Connections	PREZZO Price €	CONF. Unit/Box
338 0002	G 1/2"	24x19 fil (Ø18)	31,70	1/20

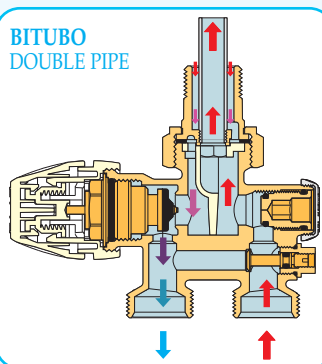

BITUBO  
DOUBLE PIPE

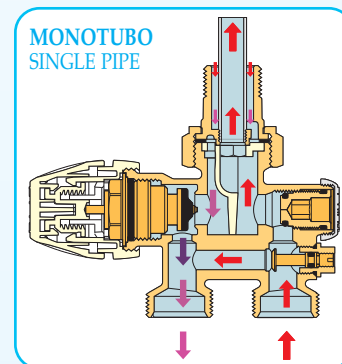

MONOTUBO  
SINGLE PIPE

### ART. 3382K - 3383K - 3385K

#### GUIDA ALLE CONNESSIONI CONNECTION GUIDE

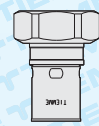
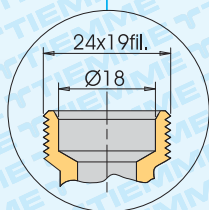
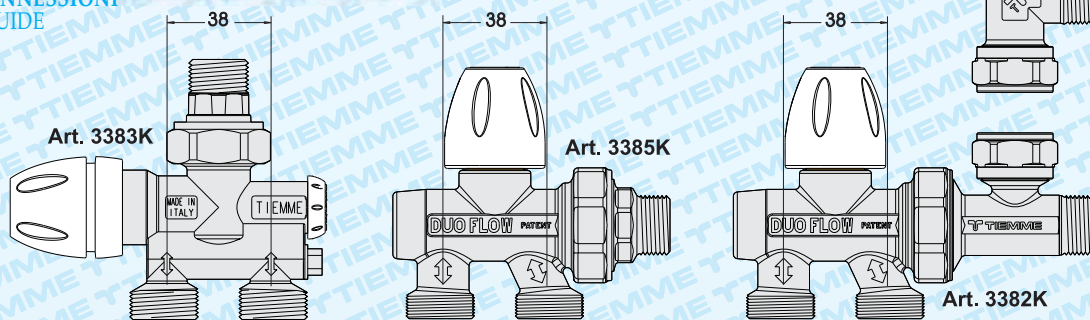

**Art. 1716**  
Per tubo Pe-x  
For Pe-x pipe

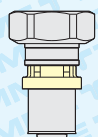

**Art. 1666K**  
Per tubo multistrato  
For multilayer pipe



**Art. 1633K**  
Per tubo multistrato  
For multilayer pipe



**Art. 1243K**  
Per tubo rame  
For copper pipe



**Art. 1433K**  
Per tubo Pe-x  
For Pe-x pipe

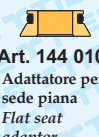

**Art. 144 0104**  
Adattatore per sede piana  
Flat seat adaptor

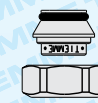

**Art. 144 0211**  
Tappo  
Cap

Per tabella giri di serraggio vedi pag 267-268 Cap. 17  
For nut tightening table see pag 267-268 Chap. 17



### ART. 3370K

Distributore con attacchi per tubi dal pavimento con portata al radiatore 50% - Attacchi 24x19 fil (Ø18) con interasse 38 mm per tubi dal pavimento - Attacco per tubo rame Ø 15 al radiatore  
*Distributor for pipes from the floor - Flow rate to the radiator 50% - Single pipe 24x19 tpi (Ø18) connection for floor pipes - Distance between centres 38 mm - Copper pipe connection Ø 15 to the radiator*

CODICE Code	TIPO Size	ATTACCHI Connections	PREZZO Price €	CONF. Unit/Box
337 0003	G 1/2"	24x19 fil (Ø18)	17,66	10/60



### ART. 3375K

Distributore con attacchi per tubi dal pavimento con portata al radiatore 100% - Attacchi 24x19 fil (Ø18) con interasse 38 mm per tubi dal pavimento - Attacco per tubo rame Ø 15 al radiatore  
*Distributor for pipes from the floor - Flow rate to the radiator 100% - Double pipe 24x19 tpi (Ø18) connection for floor pipes - Distance between centres 38 mm - Copper pipe connection Ø 15 to the radiator*

CODICE Code	TIPO Size	ATTACCHI Connections	PREZZO Price €	CONF. Unit/Box
337 0002	G 1/2"	24x19 fil (Ø18)	18,70	10/60



### ART. 3371K

Distributore con attacchi per tubi dalla parete con portata al radiatore 50% - Attacchi 24x19 (18) con interasse 38 mm per tubi dalla parete - Attacco per tubo rame Ø 15 al radiatore  
*Distributor for pipes from the wall - Flow rate to the radiator 50% - Single pipe 24x19 tpi (Ø18) connection for wall pipes - Distance between centres 38 mm - Copper pipe connection Ø 15 to the radiator*

CODICE Code	TIPO Size	ATTACCHI Connections	PREZZO Price €	CONF. Unit/Box
337 0005	G 1/2"	24x19 fil (Ø18)	27,20	10/60



### ART. 3376K

Distributore con attacchi per tubi dalla parete con portata al radiatore 100% - Attacchi 24x19 (18) con interasse 38 mm per tubi dalla parete - Attacco per tubo rame Ø 15 al radiatore  
*Distributor for pipes from the wall - Flow rate to the radiator 100% - Double pipe 24x19 tpi (Ø18) connection for wall pipes - Distance between centres 38 mm - Copper pipe connection Ø 15 to the radiator*

CODICE Code	TIPO Size	ATTACCHI Connections	PREZZO Price €	CONF. Unit/Box
337 0006	G 1/2"	24x19 fil (Ø18)	28,24	10/60

## ART. 3370K - 3371K - 3375K - 3376K

### GUIDA ALLE CONNESSIONI CONNECTION GUIDE

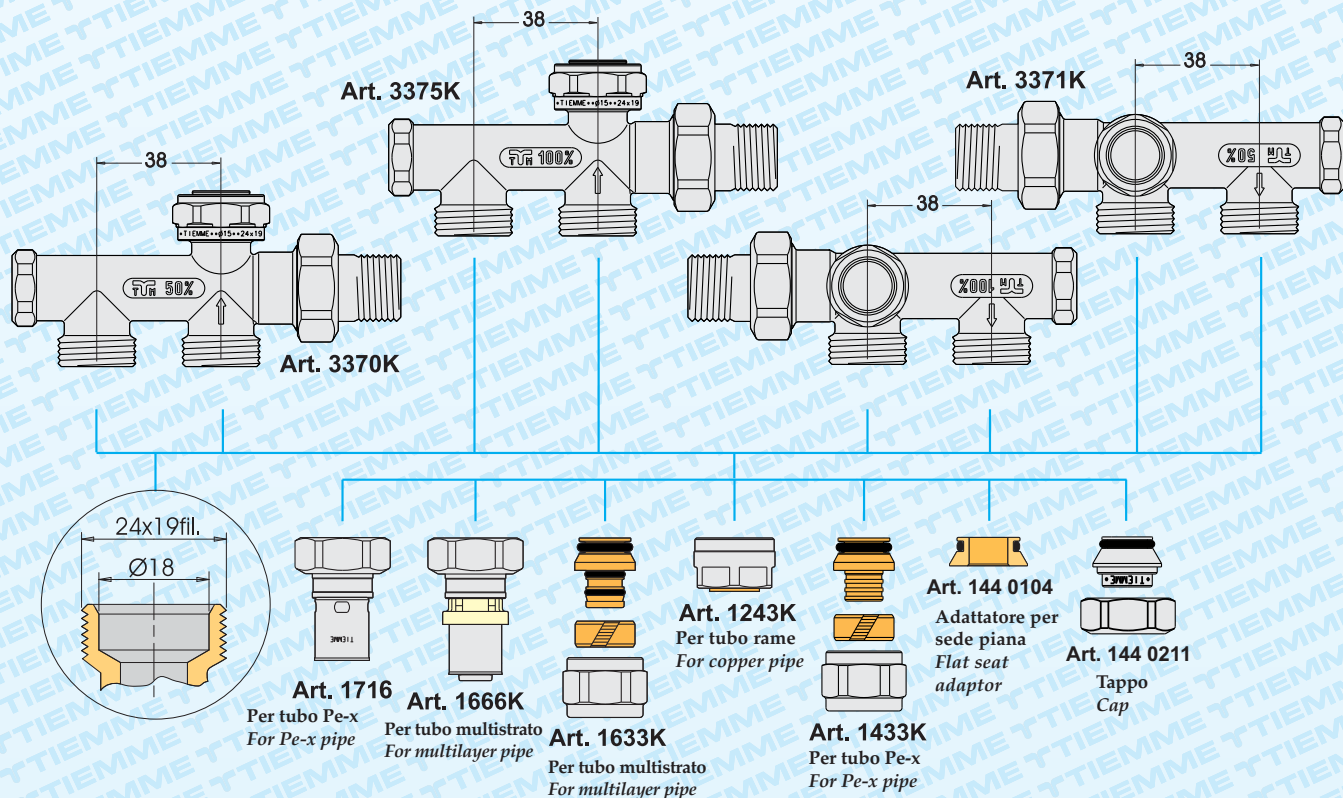

Per tabella giri di serraggio vedi pag 267-268 Cap. 17  
 For nut tightenings table see pag 267-268 Chap. 17

# VALVOLE E DISTRIBUTORI

## SPECIAL VALVES



**ART. 3361K**  
 Valvola a squadra termostattizzabile con attacco tubo rame Ø 15  
 Angle valve, thermostatic option, copper pipe Ø 15 connection

CODICE Code	TIPO Size	ATTACCHI Connections	PREZZO Price €	CONF. Unit/Box
330 0045	G 1/2"	15	17,94	10/60

Fornibile anche nella versione con cappuccio di protezione da cantiere art. 330 0089 / Available also with protection cap art. 330 0089



**ART. 3363K**  
 Valvola a squadra termostattizzabile con attacco tubo rame Ø 15  
 Angle valve, thermostatic option, copper pipe Ø 15 connection

CODICE Code	TIPO Size	ATTACCHI Connections	PREZZO Price €	CONF. Unit/Box
330 0021	G 1/2"	15	17,06	10/60

Fornibile anche nella versione con cappuccio di protezione da cantiere art. 330 0020 / Available also with protection cap art. 330 0020



**ART. 1505C**  
 Tubetto cromato Ø 15  
 Chrome-plated Ø 15 tube

CODICE Code	TIPO Size	PREZZO Price €	CONF. Unit/Box
337 0008	60 cm	3,03	10/500
337 0010	65 cm	4,05	10/1000
337 0012	90 cm	4,86	10/1000
337 0014	110 cm	5,37	10/750

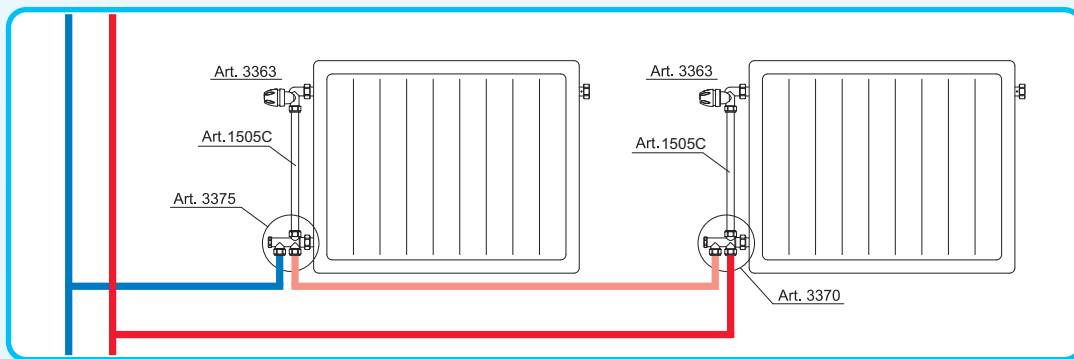
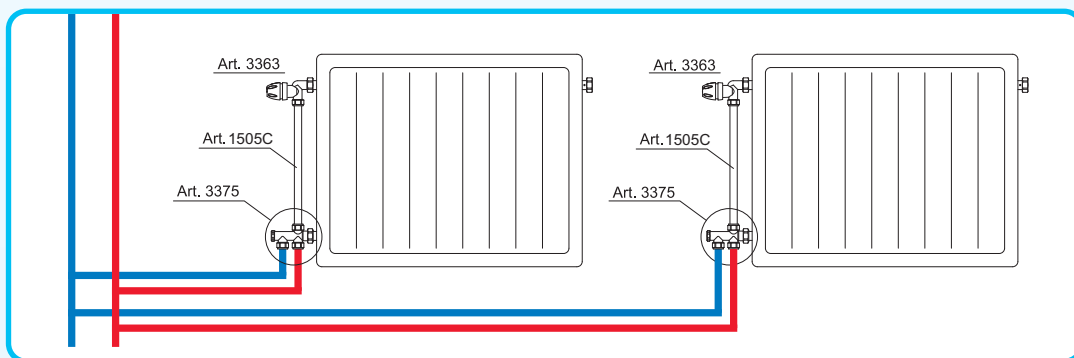

# DISTRIBUTORI BITUBO

## DOUBLE PIPES DISTRIBUTORS



### ART. 3391

Distributore bitubo per piastre convettatrici con gruppo valvola termostatica incorporato. Attacchi per tubo da pavimento e raccordi per piastra da 3/4"x18 (Eurocono)  
*Straight valve 3/4" for two-pipe systems steel panel radiators with thermostatic valve group 3/4"x18 (Euroconus). Radiator connection*



### ART. 3393

Distributore bitubo per piastre convettatrici con gruppo valvola termostatica incorporato. Attacchi per tubo da parete e raccordi per piastra da 3/4"x18 (Eurocono)  
*Angle valve 3/4" for two-pipe systems steel panel radiators with thermostatic valve group 3/4"x18 (Euroconus). Radiator connection*

CODICE Code	TIPO Size	PREZZO Price €	CONF. Unit/Box
339 0001	3/4" Fem-3/4" Euroc.	13,58	15/45
339 0010	3/4" Fem-24x19 fil	16,59	15/45

CODICE Code	TIPO Size	PREZZO Price €	CONF. Unit/Box
339 0002	3/4" Fem-3/4" Euroc.	14,76	10/30
339 0004	3/4" Fem-24x19 fil	16,59	10/30



### ART. 3391BY

Distributore bitubo per piastre convettatrici con gruppo valvola termostatica incorporato e by-pass. Attacchi per tubo da pavimento e raccordi per piastra 3/4"x18 (Eurocono)  
*Straight valve with by-pass 3/4" for two-pipe systems steel panel radiators with thermostatic valve group 3/4"x18 (Euroconus). Radiator connection*



### ART. 3393BY

Distributore bitubo per piastre convettatrici con gruppo valvola termostatica incorporato e by-pass. Attacchi per tubo da parete e raccordi per piastra da 3/4"x18 Eurocono  
*Angle valve with by-pass 3/4" for two-pipe systems steel panel radiators with thermostatic valve group 3/4"x18 (Euroconus). Radiator connection*

#### CON BY-PASS WITH BY-PASS

CODICE Code	TIPO Size	PREZZO Price €	CONF. Unit/Box
339 0007	3/4" Fem-3/4" Euroc.	21,68	15/45
339 0006	3/4" Fem-24x19 fil	26,49	15/45

#### CON BY-PASS WITH BY-PASS

CODICE Code	TIPO Size	PREZZO Price €	CONF. Unit/Box
339 0011	3/4" Fem-3/4" Euroc.	23,58	10/30
339 0005	3/4" Fem-24x19 fil	26,49	10/30



### ART. 3390RID

Riduzione per attacchi 1/2" femmina  
*Adaptor for radiators with 1/2" female connections*

CODICE Code	TIPO Size	PREZZO Price €	CONF. Unit/Box
339 0003	3/4" x 1/2"	3,03	10/250

- versione nichelata / nickel-plated version
- versione cromata / chrome-plated version

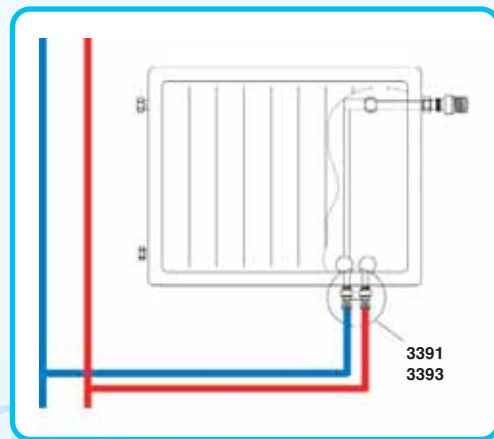

## ART. 3391K-3393K

### GUIDA ALLE CONNESSIONI CONNECTION GUIDE

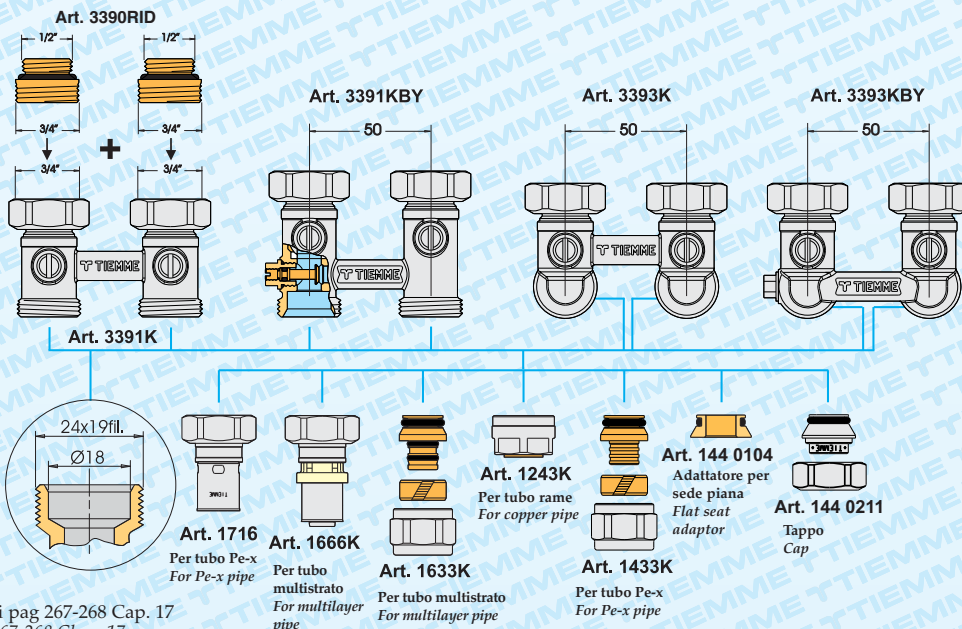

Per tabella giri di serraggio vedi pag 267-268 Cap. 17  
 For nut tightenings table see pag 267-268 Chap. 17

**ART. 3391N-3393N**

**GUIDA ALLE CONNESSIONI**  
**FITTING GUIDE**

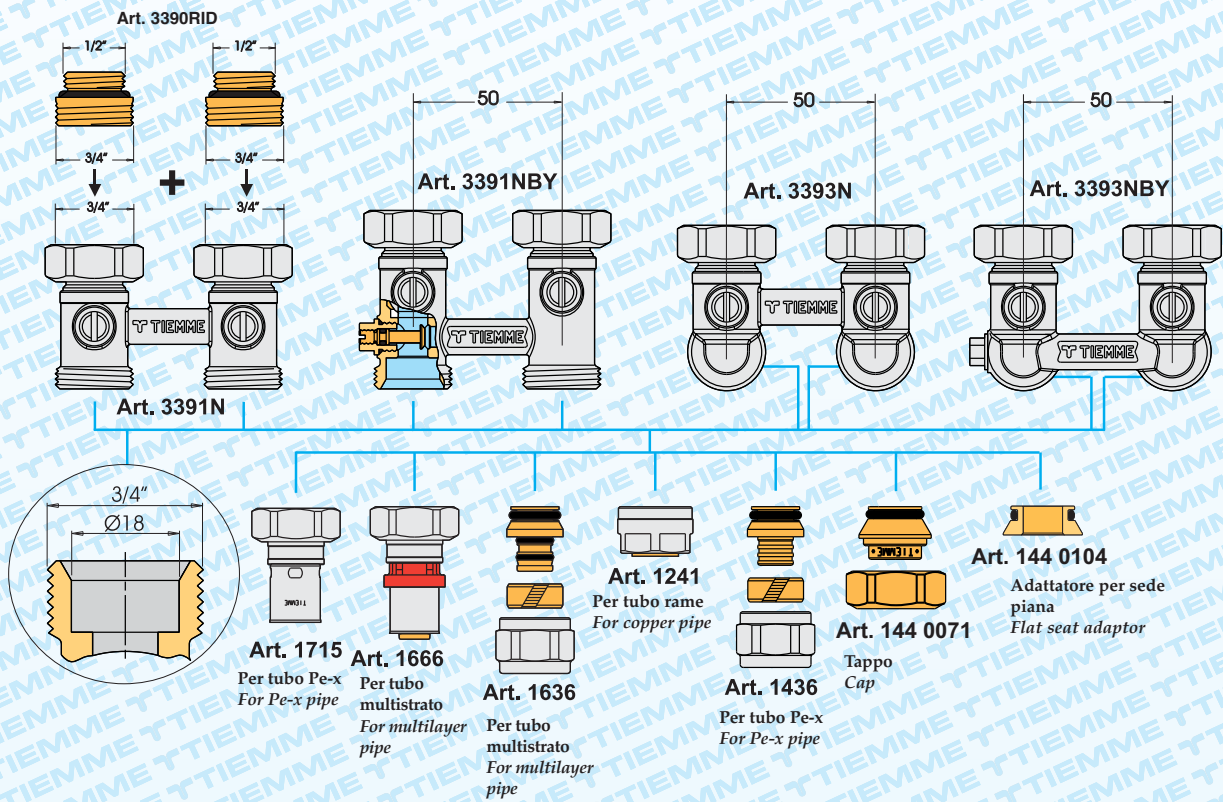

Per tabella giri di serraggio vedi pag 267-268 Cap. 17  
 For nut tightenings table see pag 267-268 Chap. 17



**ART. 9550**  
Manopola per valvole termostattabili serie 3300  
Plastic head for thermostatic valves series 3300

CODICE Code	TIPO Size	PREZZO Price €	CONF. Unit/Box
327 0006	-	1,52	5/50



**ART. 9552**  
Manopola per valvole manuali serie Excel  
Plastic head for manual valves series Excel

CODICE Code	TIPO Size	PREZZO Price €	CONF. Unit/Box
327 0008	-	0,48	5/50



**ART. 9552P06**  
Manopola per valvole manuali serie Maxima  
Plastic head for Maxima manual valves

CODICE Code	TIPO Size	PREZZO Price €	CONF. Unit/Box
327 0038	-	0,56	5/50



**ART. 3338**  
Bocchettone con guarnizione  
Tail pieces with seal

CODICE Code	TIPO Size	PREZZO Price €	CONF. Unit/Box
327 0007	3/8"	3,26	5/100
327 0003	1/2"	3,36	5/100
327 0005	3/4"	5,38	5/100



**ART. 3340**  
Rosone universale  
Universal cover for pipe

CODICE Code	TIPO Size	PREZZO Price €	CONF. Unit/Box
327 0001	Ø10 - Ø18	0,71	10



**ART. 3345N \***  
Dado + ogiva in ottone con attacco ferro G1/2" - per tubo rame  
Nut with brass rings, iron pipe connection G1/2" - for copper pipe

CODICE Code	TIPO Size	PREZZO Price €	CONF. Unit/Box
327 0010	10 x 1/2"	2,01	10
327 0009	12 x 1/2"	1,99	10
327 0011	14 x 1/2"	1,94	10
327 0002	15 x 1/2"	1,94	10
327 0012	16 x 1/2"	1,94	10

\* utilizzare con valvole e detentori serie 3300  
to be used with valves and lockshields 3300 series



**ART. 3342**  
Rosone universale doppio con interasse 38 mm  
Double universal cover for pipe with distance between centres 38 mm

CODICE Code	TIPO Size	PREZZO Price €	CONF. Unit/Box
327 0004	Ø10 - Ø18	2,06	1/50



**ART. 9760**  
Chiave esagonale per DUO FLOW  
Exagonal spanner for DUO FLOW

CODICE Code	TIPO Size	PREZZO Price €	CONF. Unit/Box
338 0004	unica - single	1,25	10

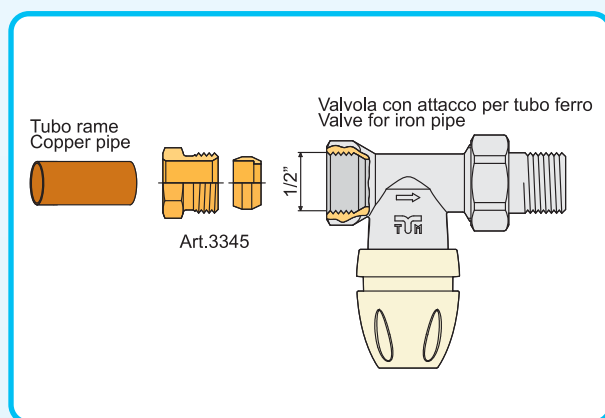



**ART. 3350**  
Valvola di sfiato per radiatori  
*Air vent valve for radiators*

CODICE Code	TIPO Size	PREZZO Price €	CONF. Unit/Box
198 0021	1/8"	vedi cap. 21	10/500
198 0020	1/4"	vedi cap. 21	10/500
198 0015	3/8"	vedi cap. 21	10/500
198 0016	1/2"	vedi cap. 21	10/500



**ART. 3351**  
Valvola di sfiato per radiatori  
con anello di pretenuta  
*Air vent valve with O-ring for radiators*

CODICE Code	TIPO Size	PREZZO Price €	CONF. Unit/Box
198 0010	1/4"	vedi cap. 21	10/500
198 0008	3/8"	vedi cap. 21	10/500
198 0006	1/2"	vedi cap. 21	10/500



**ART. 3352**  
Valvola di sfiato per radiatori  
con taglio cacciavite  
*Air vent valve with screwdriver cut for radiators*

CODICE Code	TIPO Size	PREZZO Price €	CONF. Unit/Box
198 0018	1/2"	vedi cap. 21	10/500



**ART. 1829Z**  
Coppia staffette fissaggio  
radiatore  
*Couple of brackets for radiators*

CODICE Code	TIPO Size	PREZZO Price €	CONF. Unit/Box
076 0002	unica - single	1,71	25/100