

SCHUKO® -

10839



/

3 x 2,5 2,

H07RN-F

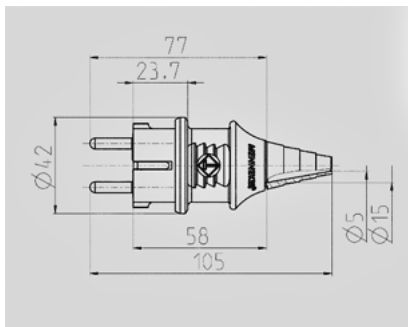

	16 A
	2 +
	230 B
T	
	IP 44

 Чертеж  
2 МВ 139

Размеры, мм.