

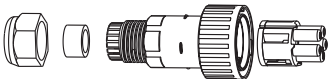

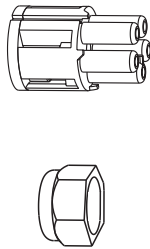
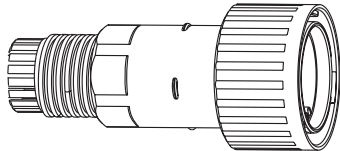
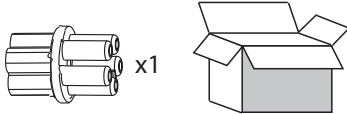
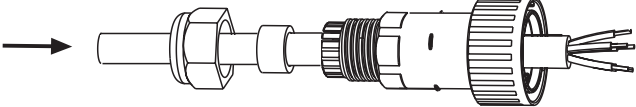
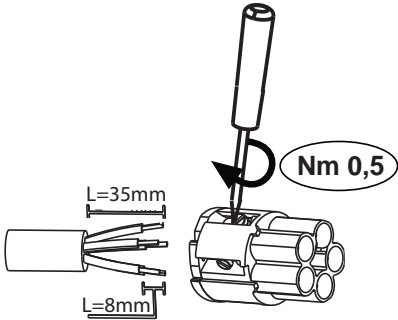
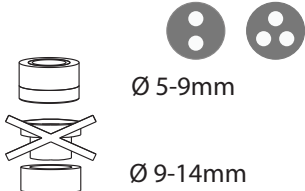
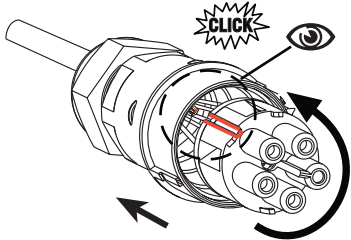

ASENNUSOHJE
 INSTALLATIONSANVISNING
 INSTALLATION INSTRUCTION
 MONTAGEANWEISUNG
 NOTICE DE MONTAGE

PEM369
 17.1.2011

WetNet

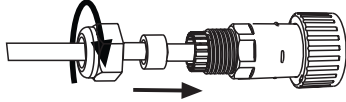
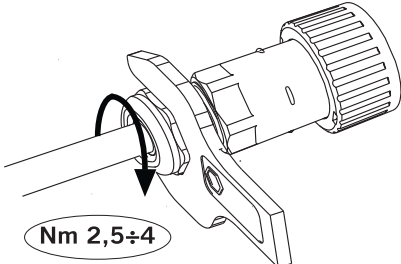
<p>1</p> <p>NWC...</p> 	  
<p>2</p> 	
<p>3</p> 	
<p>4</p> 	
<p>5</p> 	<div style="border: 1px solid red; padding: 5px;"> <p>Max. 0,5 bar 5 metriin yhden (1) tunnin ajan. Max. 0,5 bar på 5 meters djup i en (1) timme. Max. 0.5 bar pressure in 5 meters under water for one (1) hour. Max. druck 0.5 bar 5 Meter unter Wasserbergrenze während einer (1) Stunde. Pression max. 0,5 bar sous 5 mètres d'eau pendant une (1) heure</p> </div>
<p>6</p> 	



ENSTO FINLAND OY
 Building Technology
 P.O. BOX 77
 FI-06101 PORVOO, FINLAND
 www.ensto.com

Tekninen tuki (Suomi): 0200 29 009
 Int. tel.: +358 204 76 21
 Sweden: +46 8 556 30900
 Norway: +47 22 90 44 00

France: +334 68 57 20 20
 Italy: +39 2 294 030 84
 Москва, тел.: +7 495 258 52 70
 Санкт-Петербург тел.: +7 495 258 52 70



ASENNUSOHJE
INSTALLATIONSANVISNING
INSTALLATION INSTRUCTION
MONTAGEANWEISUNG
NOTICE DE MONTAGE

PEM369
17.1.2011

WetNet

1

NWA...

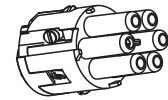
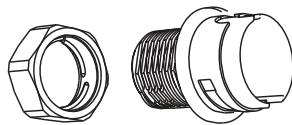

2

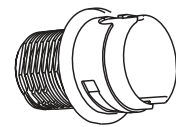
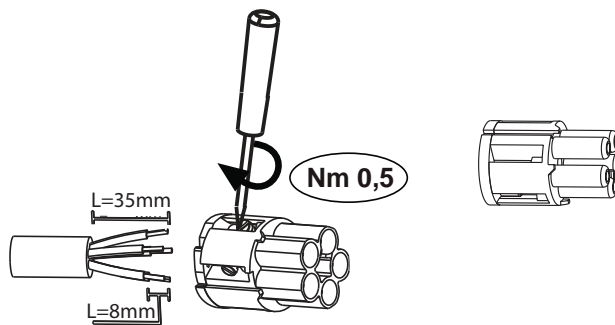

3

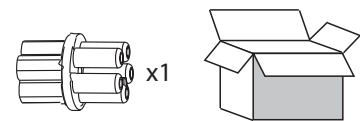
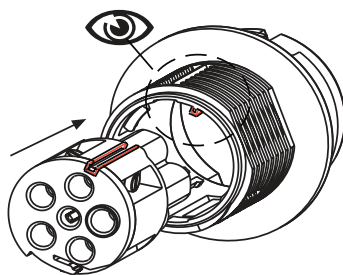

4

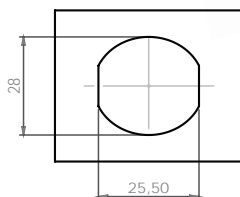
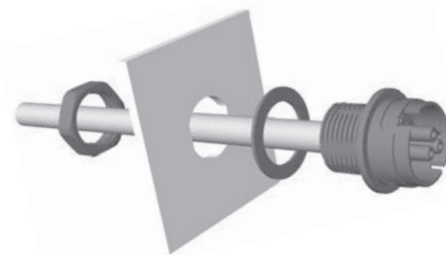

Max. 0,5 bar 5 metriin yhden (1) tunnin ajan.
Max. 0,5 bar på 5 meters djup i en (1) timme.
Max. 0.5 bar pressure in 5 meters under water for one (1) hour.
Max. druck 0.5 bar 5 Meter unter Wasserobergrenze während einer (1) Stunde.
Pression max. 0,5 bar sous 5 mètres d'eau pendant une (1) heure



ENSTO FINLAND OY
Building Technology
P.O. BOX 77
FI-06101 PORVOO, FINLAND
www.ensto.com

Tekninen tuki (Suomi): 0200 29 009
Int. tel.: +358 204 76 21
Sweden: +46 8 556 309 00
Norway: +47 22 90 44 00

France: +334 68 57 20 20
Italy: +39 2 294 030 84
Москва, тел.: +7 495 258 52 70
Санкт-Петербург тел.: +7 495 258 52 70