

-

212A



TorsionSpringCONTACT

:

+

P

	125 A
	4
	400 B
	6
	50-60
T	, TorsionSpringCONTACT
	IP 67

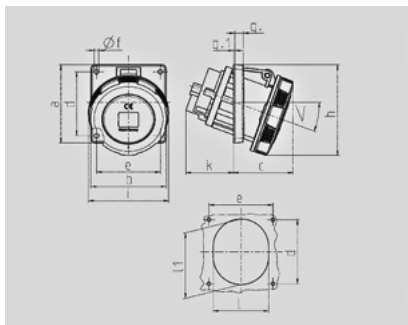

	A	63			125		
	Полоса	3	4	5	3	4	5
Размеры, мм.	a	110	110	110	114	114	114
	b	106	106	106	110	110	110
	c	85	85	85	75	75	75
	d	85	85	85	90	90	90
	e	77	77	77	90	90	90
	f	6,2	6,2	6,2	6,2	6,2	6,2
	g	12	12	12	13	13	13
	g-1	2	2	2	2	2	2
	h	128	128	128	133	133	133
	i	113	113	113	126	126	126
	k	67	67	67	103	103	103
	l	92	92	92	94	94	94
	ll	98	98	98	107	107	107
	<	20°	20°	20°	15°	15°	15°
Клеммы для кабеля		6	6	6	25	25	25
сечением от до мм*		-25	-25	-25	70	70	70