



- 1485



20°

	16 A
	5
	400 B
	6
	50-60
T	
	IP 67

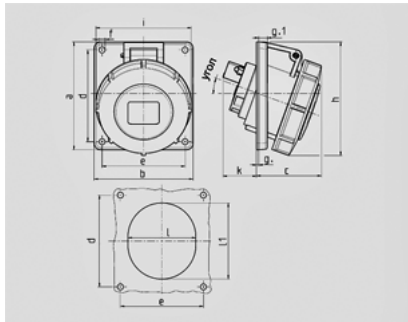

Чертеж 1 MB 251	A Полоса	16			32		
		3	4	5/7	3	4	5/7
Размеры, мм.	a	73,5	100	100	100	100	100
	b	64	92	92	92	92	92
	c	52	60	62	64	64	66
	d	60	85	85	85	85	85
	e	52	77	77	77	77	77
	f	5,5	5,5	5,5	5,5	5,5	5,5
	g	8	8	8	8	8	8
	g.1	2	2	2	2	2	2
	h	84	100	105	109	109	113
	i	78	85	96	103	103	110
	k	43	32	32/39	53	53	45/54
	l	52	55	65	67	67	72
	lt	60	63	72	82	82	85
	o	20°	20°	20°	20°	20°	20°
Клеммы для кабеля сечением от до мм²		1,5	1,5	1,5	2,5	2,5	2,5
		-4	-4	-4	-10	-10	-10