

SCHUKO® -
10081

- C
- 3
-
- C

 M 20 x 1,5 c
) c

 1,5 - 2,5 2
, M 20 x 1,5 (

	16 A
	2 +
	230 B
T	.
	IP 44

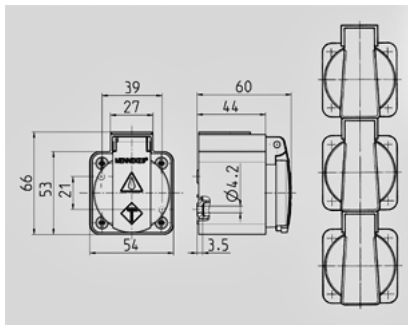
 Чертеж
1 MB 27/30
Размеры, мм.